



## Shunt Switches Protected terminals

### **DER**

DIN standard shunt  
for direct current instruments



### **C48**

ammetric and voltmetric switches  
panel front frame 48x48 mm



### **CD3**

ammetric and voltmetric switches  
3 module



### **AV**

protected terminals for KWh-meters



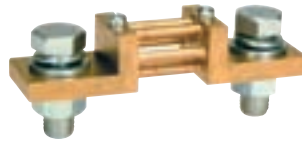

Model	DER								
	60mV			100mV			150mV		
Ordering code	Stock		Ordering code	Stock		Ordering code	Stock		
1A	DER060A100	•	DER100A100			DER150A100			
1,5A	DER060A150	•	DER100A150			DER150A150			
2A	DER060A200	•	DER100A200			DER150A200			
2,5A	DER060A250	•	DER100A250			DER150A250			
3A	DER060A300	•	DER100A300			DER150A300			
4A	DER060A400	•	DER100A400			DER150A400			
5A	DER060A500	•	DER100A500			DER150A500			
6A	DER060A600	•	DER100A600			DER150A600			
8A	DER060A800	•	DER100A800			DER150A800			
10A	DER060B100	•	DER100B100			DER150B100	•		
15A	DER060B150	•	DER100B150			DER150B150	•		
20A	DER060B200	•	DER100B200			DER150B200			
25A	DER060B250	•	DER100B250			DER150B250	•		
30A	DER060B300	•	DER100B300			DER150B300			
40A	DER060B400	•	DER100B400			DER150B400	•		
50A	DER060B500	•	DER100B500			DER150B500			
60A	DER060B600	•	DER100B600			DER150B600	•		
80A	DER060B800	•	DER100B800			DER150B800			
100A	DER060C100	•	DER100C100			DER150C100	•		
120A	DER060C120	•	DER100C120			DER150C120			
150A	DER060C150	•	DER100C150			DER150C150	•		
200A	DER060C200	•	DER100C200			DER150C200			
250A	DER060C250	•	DER100C250			DER150C250	•		
300A	DER060C300	•	DER100C300			DER150C300			
400A	DER060C400	•	DER100C400			DER150C400	•		
500A	DER060C500	•	DER100C500			DER150C500			
600A	DER060C600	•	DER100C600			DER150C600	•		
800A	DER060C800	•	DER100C800			DER150C800			
1000A	DER060D100	•	DER100D100			DER150D100			
1200A	DER060D120	•	DER100D120			DER150D120			
1500A	DER060D150	•	DER100D150			DER150D150			
2000A	DER060D200	•	DER100D200			DER150D200			
2500A	DER060D250	•	DER100D250			DER150D250			
3000A	DER060D300		DER100D300			DER150D300			
4000A	DER060D400		DER100D400			DER150D400			
5000A	DER060D500		DER100D500			DER150D500			
6000A	DER060D600		DER100D600			DER150D600			



# Voltmetric and ammetric switches



Model	C48								
Execution	switchboard, front frame 48x48 mm								
Description	Ordering code	Stock		Ordering code	Stock		Ordering code	Stock	
Single pole ammetric switch for 3 C.T. (12A-690V)	AV104	•							
3 interlinked voltages voltmetric switch (12A-690V)				AV105	•				
3 interlinked voltages and 3-phase neutral voltmetric (12A-690V)							AV106	•	



Model	CD3								
Execution	backboard, 3 module								
Description	Ordering code	Stock		Ordering code	Stock		Ordering code	Stock	
Single pole ammetric switch for 3 C.T. (12A-690V)	AV114	•							
3 interlinked voltages voltmetric switch (12A-690V)				AV115	•				
3 interlinked voltages and 3-phase neutral voltmetric (12A-690V)							AV116	•	

# Protected terminals for KWh-meter



Description	Ordering code	Stock		Ordering code	Stock	
protected terminal for KWh-meter 3-phase 2 systems	<b>AV201</b>	•				
protected terminal for KWh-meter 3-phase 3 systems				<b>AV202</b>	•	

Switches

AV104 / AV114

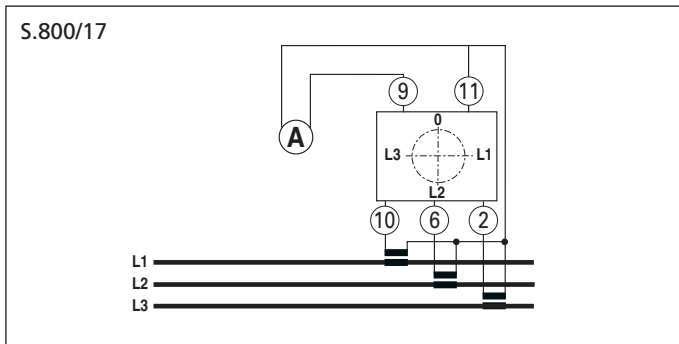

AV105 / AV115

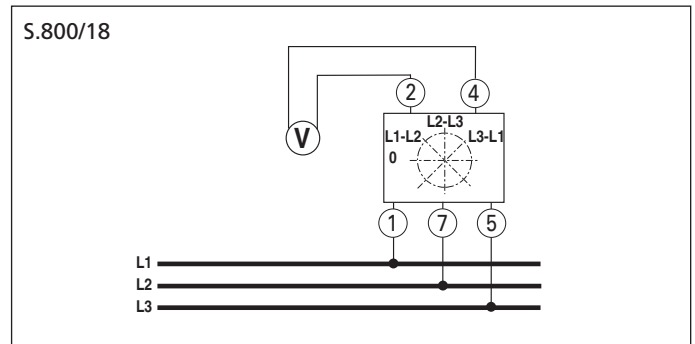

AV106 / AV116

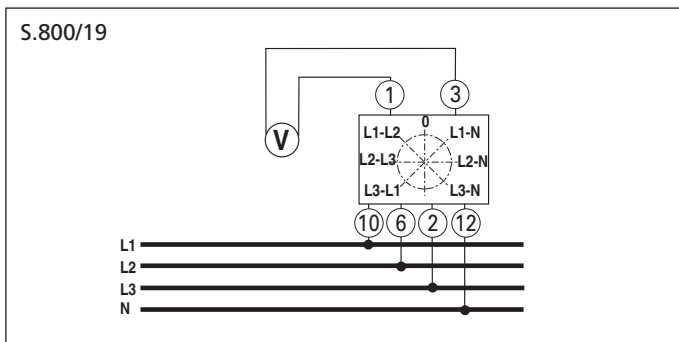

Protected terminals

AV201

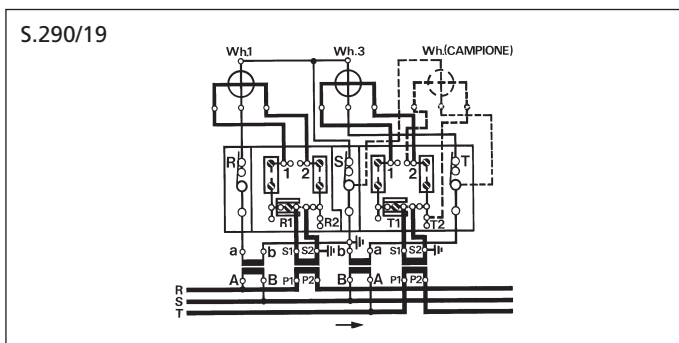

3-phase 2 systems KWh-meters

AV202

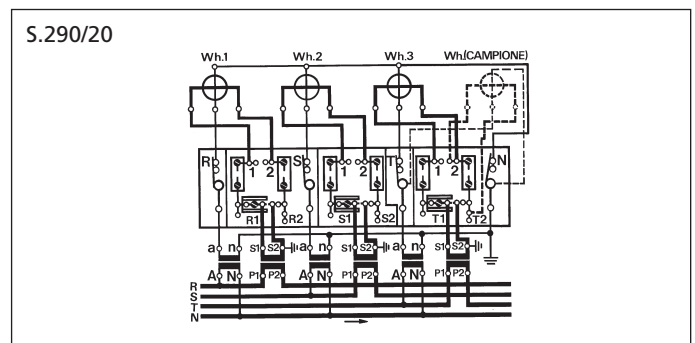

3-phase 3 systems KWh-meters

## DER

DER series according to DIN standard (excluded 200A / 60mV / 150mV)

Range A	fig.	A	B	C	D	E	F	G	H	I
<b>Voltage drop 60mV</b>										
1-1,5-2-2,5-3-4-5	1	90	28	20	—	—	8	—	78	—
6-8-10-15-20-25	1	90	28	20	—	—	8	—	78	—
30-40-50-60-80-100-120-150-200	1	100	33	20	—	—	8	—	80	—
250-300	2	145	55	30	—	—	10	10	105	30
400-500-600	2	145	55	40	—	—	10	10	105	30
800-1000	2	165	65	60	—	—	10	10	115	30
1200-1500	3	165	65	90	21	48	10	10	115	30
2000-2500	3	165	65	120	30	60	10	10	115	30
3000-4000	4	165	65	120	30	60	15	10	115	60
5000-6000	5	175	70	154	25	52	25	15	125	130
<b>Voltage drop 100mV</b>										
1-1,5-2-2,5-3-4-5	1	90	28	20	—	—	8	—	78	—
6-8-10-15-20-25	1	90	28	20	—	—	8	—	78	—
30-40-50-60-80-100-120-150	1	123	33	20	—	—	8	—	103	—
200-250-300	2	168	55	30	—	—	10	10	128	30
400-500-600	2	168	55	40	—	—	10	10	128	30
800-1000	2	188	65	60	—	—	10	10	138	30
1200-1500	3	188	65	90	21	48	10	10	138	30
2000-2500	3	188	65	120	30	60	10	10	138	30
3000-4000	4	188	65	120	30	60	15	10	138	60
5000-6000	5	198	70	154	25	52	25	15	148	130
<b>Voltage drop 150mV</b>										
1-1,5-2-2,5-3-4-5	1	90	28	20	—	—	8	—	78	—
6-8-10-15-20-25	1	90	28	20	—	—	8	—	78	—
30-40-50-60-80-100-120-150-200	1	225	33	25	—	—	8	—	205	—
250-300	2	270	55	30	—	—	10	10	230	30
400-500-600	2	270	55	40	—	—	10	10	230	30
800-1000	2	290	65	60	—	—	10	10	240	30
1200-1500	3	290	65	90	21	48	15	10	240	60
2000-2500	3	290	65	120	30	60	15	10	240	60
3000-4000	4	300	70	120	30	60	25	15	250	130
5000-6000	5	300	70	154	25	52	25	15	250	130

Fig. 1

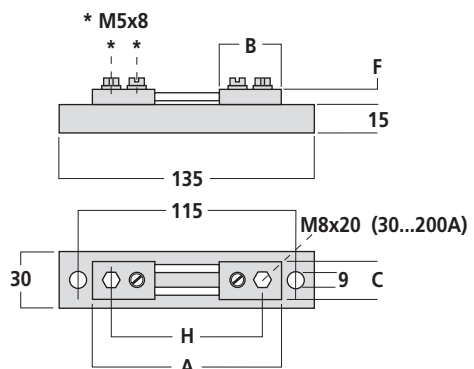

On base up to 25A

Fig. 2

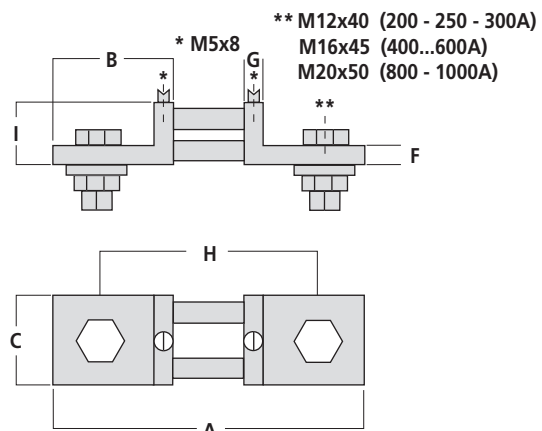

Fig. 3

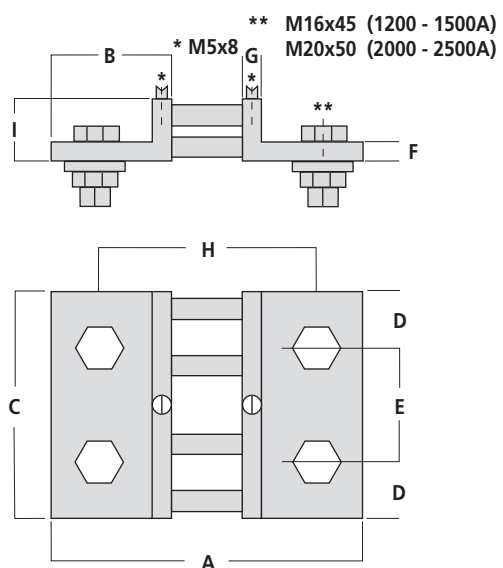

Fig. 4

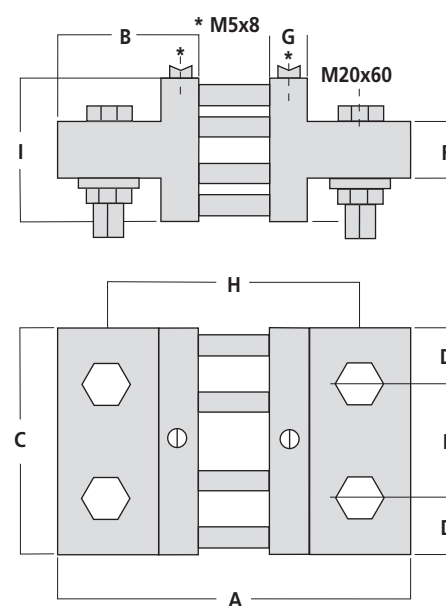
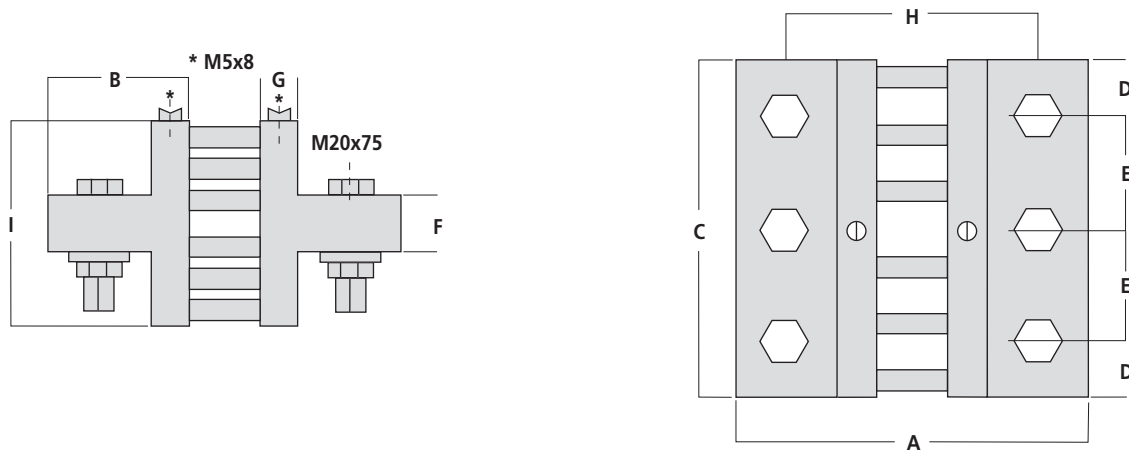
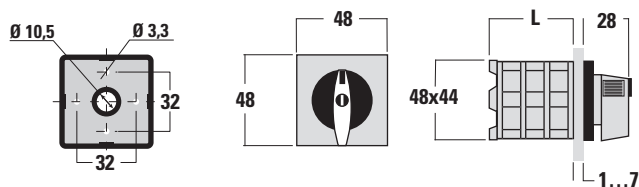

Fig. 5



## AV104 / AV105 / AV106 - panel switch



AV105 (L = 53) / AV104 - 106 (L = 63)

## AV114 / AV115 / AV116 - backboard switch

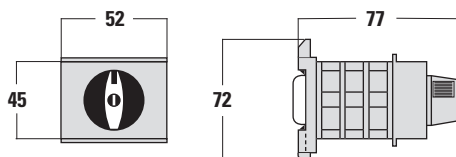

3 Module

## AV201 - protected terminal

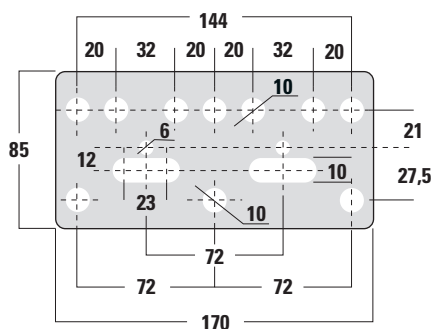

## AV202 - protected terminal

