

Digital Panel Meters

Modular Indicator and Controller for pulse signals

Type UDM60



- Dual 6-DGT μ P-based controller with analogue indicators
- Dual rate, speed, frequency and period measurement
- Dual counter
- 0.001% RDG basic accuracy
- Range from 0.001Hz to 50kHz/20 μ s to 1000s
- Scalable inputs and counters
- Linearization of the inputs up to 16 points
- Special calculation functions
- NPN, PNP, NAMUR, TTL, Pick-up, free of voltage contacts and AC signal inputs
- Up to 4 independent alarm set-points (optional)
- 20mA/10VDC analog output (optional)
- Serial port RS485 or RS232 (optional)
- MODBUS, JBUS communication protocol
- Front protection degree: IP67, NEMA12
- Backlighted LCD display

Product Description

μ p-based digital panel meter, dual 6-DGT LCD indicator with analogue indicators, for rate, speed, frequency and period measurements. Measuring ranges, scaling and functions easily programmable from the keypad or from the PC by

means of optional UdmSoft software. UDM60 includes storage min-max functions and double level protection password. Housing for panel mounting with front protection degree: IP67, NEMA12.

How to order

UDM60 XXX XX XX X XX



How to order

UdmSoft-kit

UdmSoft-kit: software plus communication cable for programming UDM60 by means of PC.

UdmSoft: software for programming UDM60 by means of PC, downloadable from www.carlogavazzi.com.

Type Selection

Slot A (measuring inputs)	Slot B (communication)	Slot C (communication and alarm)	Slot D (power supply)
TF1: 0.001Hz to 50kHz for DC signals: PNP, NPN, NAMUR, TTL, free of voltage, contacts, voltages up to 14VDC TF2: 0.001Hz to 50kHz for AC signals: pick-up, voltages up to 500VAC	XX: None SX: Serial port RS485 SY: Serial port RS232 AV(*): Single analogue output, 0 to 20mA DC and 0 to 10V DC (*): The two analogue outputs cannot be used at the same time. It is possible to plug in only one module by instrument.	XX: None R1: Single relay output, (AC1-8AAC, 250VAC) R2: Dual relay output, (AC1-8AAC, 250VAC) R4: Dual relay output, (AC1-8AAC, 250VAC) + dual open collector output (NPN, 100mA) R5: 4 relay outputs (AC1-5AAC, 250VAC) AV(*): Single analogue output, 0 to 20mA DC and 0 to 10V DC	H: 90 to 260V AC/DC L: 18 to 60V AC/DC Options XX: None TX: Tropicalization

Input specifications

Analogue inputs BQ TF1 module	Channels and variables 2, 0.001Hz to 50kHz for DC signals: PNP, NPN, NAMUR, TTL, free of volt- age contacts, voltages up to 14VDC.	Contact reading signal	- counter(s) reset - latch and counter reset BQ TF1: <6 mA, <7 VDC BQ TF2: <0.25 mA, <3 VDC
BQ TF2 module	2, 0.001Hz to 50kHz for AC signals: pick-up, voltages up to 500VAC.	Close contact resistance Open contact resistance Insulation	Max 1kΩ. Min 100kΩ. Non-insulated.
ON signal minimum time duration Rotation speed detection	0.001Hz to 50kHz, 10μs. Max 1kHz, duty cycle 50%.	Accuracy (display, RS485)	See table "Measuring accuracy", temperature drifts and minimum/maxi- mum indications"
Type of input NPN (DC)	Signal level: ON < 2VDC, OFF open collector (leak- age current <=1mA).	Additional errors Humidity	0.05% RDG, 60% to 90% R.H. .
PNP (DC)	Signal level: ON >10VDC, OFF open collector (leak- age current <=1mA).	Magnetic field	0.05% RDG @ 400 A/m.
NAMUR (DC)	Signal level: ON <= 1mADC, OFF >= 2.2 mADC.	Temperature drift	See table "Measuring accuracy", temperature drifts and minimum/maxi- mum indications"
TTL (DC)	Signal level: ON >4VDC, OFF <=2VDC.	Display	2 lines, 6-digit + 2 ana- logue indicators. 7 segments. h= 10.0 mm
Free of voltage contact(DC)	Input load: ON <1kohm, OFF >20kohm.	Max and min indication	See table "Measuring accuracy", temperature drifts and minimum/maxi- mum indications"
Pick-up (AC)	Signal level: ON > 2VAC (5.62Vpp).	Measurements Up to 1 kHz From 1 kHz	Zero-crossing detection. Zero-crossing detection with divisor.
Voltage (AC) up to 100VAC	Signal level: ON > 2VAC (5.62Vpp).	Input impedance	See table "Input impedance and overflow"
Voltage (AC) up to 500VAC	Signal level: ON > 9VAC (24.5Vpp).	Overloads	See table "Input impedance and overflow"
Digital inputs	Included in the measuring module.		
Number of inputs Use	1 (contact). - display HOLD command - key-pad disabling - latch alarm reset		

Measurement accuracy, temp. drifts, max and min indications

All accuracies and min/max indications are referred to an ambient temp. range of 25°C ±5°C, rel. humidity ≤60% and scale ratio (electrical/displayed scale) equal to 1.

Module	Input type	Accuracy	Temp. drift	Min indication (■)	Max indication
BQ TF1	NPN (DC) PNP (DC) NAMUR (DC) TTL (DC) Free of voltage contact (DC)	0.001% RDG ±3 digit	± 50 ppm/°C	0.00000 00.0000 000.000 0000.00 00000.0 000000	9.99999 99.9999 999.999 9999.99 99999.9 999999
BQ TF2	Pick-up (AC) Voltage (AC) up to 100VAC Voltage (AC) up to 500VAC	0.001% RDG ±3 digit	± 50 ppm/°C	0.00000 00.0000 000.000 0000.00 00000.0 000000	9.99999 99.9999 999.999 9999.99 99999.9 999999

(■) The min indication is -9.99999, ..., -999999 in case of "rotation speed detection" function

Input impedance and overloads

Module	Input type	Impedence	Overload (continuos)	Overload (1s)
BQ TF1	NPN (DC)	600 Ω	15 VAC/DC	20 VAC/DC
	PNP (DC)	600 Ω	15 VAC/DC	20 VAC/DC
	NAMUR (DC)	600 Ω	15 VAC/DC	20 VAC/DC
	TTL (DC)	600 Ω	15 VAC/DC	20 VAC/DC
	Free of voltage contact (DC)		15 VAC/DC	20 VAC/DC
BQ TF2	Pick-up (AC) Voltage (AC) up to 100VAC	220 k Ω	120 VAC/DC	200 VAC/DC
	Voltage (AC) up to 500VAC	950 k Ω	600 VAC/DC	600 VAC/DC

Output specifications

RS422/RS485	(on request) Module: BR SX Bidirectional (static and dynamic variables). Display of data reception/transmission Multidrop, 2 or 4 wires, 1000 m Directly on the module by means of jumper 1 to 255, selectable by means of key-pad MODBUS RTU/JBUS		down alarm, down alarm with start-up deactivation up alarm with latch, down alarm with latch Adjustable from 0 to 100% of displayed electric range 0 to 100% of displayed range 0 to 255 s 0 to 255 s Selectable: normally energized /de-energize 500 ms, with filter excluded, without alarm activation delay
Serial output		Alarm set-point	1 with module BO R1 (relay output).
LED		Hysteresis	2, independent with module BO R2 (2 relay outputs).
Connections		On-time delay	4, independent with module BO R4 (2 relay outputs + 2 open collector outputs).
Distance		Off-time delay	BO R5 (4 relay outputs)
Terminalization		Output status	Type SPDT AC 1: 8A, 250VAC DC 12: 5A, 24VDC AC 15: 2.5A, 250VAC DC 13: 2.5A, 24VDC
Addresses		Output channels	Type SPST (NO) AC 1: 5A, 250VAC DC 12: 3A, 24VDC AC 15: 1.5A, 250VAC DC 13: 1.5A, 24VDC
Protocol		Min response time	4000 V _{RMS} output to measuring input, 4000 V _{RMS} output to power supply input.
Data (bidirectional)		Relay output BO R1, R2, R4	NPN transistor type V _{ON} 1.2 VDC/ max. 100 mA V _{OFF} 30 VDC max. By means of opto-couplers 4000 V _{RMS} output to
Dynamic (reading only)	Measurement, min value max value alarm status		
Static (reading/writing)	All programming parameters, min max reset reset of latch alarm 8 data bit, no parity, 1 stop bit		
Data format		Relay output BO R5	
Baud rate	selectable 4800, 9600, 19200 and 38400 bit/s		
Insulation	By means of opto-couplers 4000 V _{RMS} output to measuring inputs 4000 V _{RMS} output to power supply input		
RS232	(on request) Module: BR SY Bidirectional (static and dynamic variables) 3 wires, max. 15m 1 start bit, 8 data bit, no parity, 1 stop bit Selectable 4800, 9600, 19200 and 38400 bit/s Same as RS422/485		
Serial output		Insulation	
Connections		Open collector output	
Distance			
Data format			
Baud rate			
Other features		Insulation	
Alarm outputs	(on request) Over-range alarm, up alarm,		
Alarm type			

Output specifications (cont.)

	measuring input 4000 V _{RMS} output to power supply input		measuring input 4000V _{RMS} output to power supply input
Analogue output	(on request) Module: BO AV	Notes:	The two outputs cannot be used at the same time.
Range	0 to 20 mADC, 0 to 10 VDC	Excitation output	8.2 VDC ±10%, max 10mA 13 VDC ±10%, max 40mA
Scaling factor	Programmable within the entire retransmission range; allows to manage the retransmission of all the values from	Isolation	25 Vrms between aux. output and measuring inputs 4000 V _{RMS} between aux. output and the other input/outputs
Accuracy	0 to 20 mA / 0 to 10V ± 0.2% FS (@ 25°C ± 5°C)		
Response time	≤ 10 ms		
Temperature drift	± 200 ppm/°C		
Load: 20 mA output	≤ 700 Ω		
10 V output	≥ 10 kΩ		
Insulation	By means of opto-couplers 4000V _{RMS} output to		

Software functions

Password	Numeric code max 4 dgt 2 levels of data protection. 1st level 0 to 4999 com- pletely protected. 2nd level 5000 to 9999 access to programming is protected, while alarm set-points are directly programmable from the measuring mode.	Filter action	On measurements, serial output, analogue output
Scaling parameters		Operating modes	See “list of selectable func- tions and variables”
Pulse per revolution	Programmable and inde- pendent per each channel (only in case of dual fre- quency meter), from 1 to 9999.	Displayed values	See “list of selectable func- tions and variables”
Input engineering unit	Programmable among Hz, kHz, rpm, krpm, rph, krph, and independent per each channel (only in case of dual frequency meter).	Min max storage	Automatic storage (in the EEPROM) of the minimum and maximum measured values from the previous memory reset
Scaling	Selection of the decimal point, min value and max value of the input range (expressed in engineering units). Selection of the dec- imal point, min value and max value of the displayed range correspondent to the input range.	Setpoint modification	Direct access to the set- point modification from the measuring mode (if allowed by the selected password).
Linearisation	Programmable and inde- pendent per each channel (only in case of dual fre- quency meter).	Latch alarm reset	Direct access to the reset from the measuring mode.
Points	Up to 16	Counter reset	Direct access to the reset from the measuring mode.
Range	Input value and displayed value of each point within the programmable input and display range	Analogue indicators	11 positions (9 values between the minimum dis- play value and the max- imum display value, under- flow and overflow) or speed rotation direction.
Filter		Diagnostic	
Operating range	0 to 100% of the displayed value of channel A	Overflow/Underflow	Analogue indicator over- flow or underflow position
Filtering coefficient	1 to 32	Display over range	“EEE” indication
		Electrical full scale or overload	“Err” indication
		UdmSoft	Software for programming UDM60 by means of PC (Windows 95, 98se, ME, XP) by means of serial port RS485 and relevant con- nection cable. The soft- ware is available in English, Spanish, Italian, German, French. See also “Pro- gramming of UDM60 by means of PC”.

General specifications

Operating temperature	0°C to +50°C (32°F to 122°F) (R.H. ≤ 90% non-condensing)	Connections Cable cross-section area	Screw-type Max. 2.5 mm ² ; Min./Max. screws tightening torque: 0.4 Nm / 0.6 Nm
Storage temperature	-10°C to +60°C (-14°F to 140°F) (R.H. ≤ 90% non-condensing)	Housing DIN Dimensions (WxHxD) Material	48 x 96 x 105 mm PC-ABS, self-extinguishing: UL 94 V-0
Insulation reference voltage	300 V _{RMS} to ground (500V input)	Protection degree Front Screw terminals	IP67, NEMA12 IP20
Insulation	See table "Insulation between input and outputs"	Weight	Approx. 520 g (packing included)
Dielectric strength	4000 VRMS for 1 minute	Approvals	CE, UR, CSA
Noise rejection NMRR CMRR	40dB, 40 to 60 Hz 100 dB, 48 to 62 Hz		
EMC	EN61000-6-2, IEC61000-6-2 EN61000-6-3, IEC61000-6-3		
Standard compliance Safety	EN61010-1, IEC61010-1		

Supply Specifications

AC/DC voltage	90 to 260V (standard) 18 to 60V (on request)	Energy consumption	≤ 30VA/12W (90 to 260V) ≤ 20VA/12W (18 to 60V)
----------------------	---	---------------------------	---

Excitation output

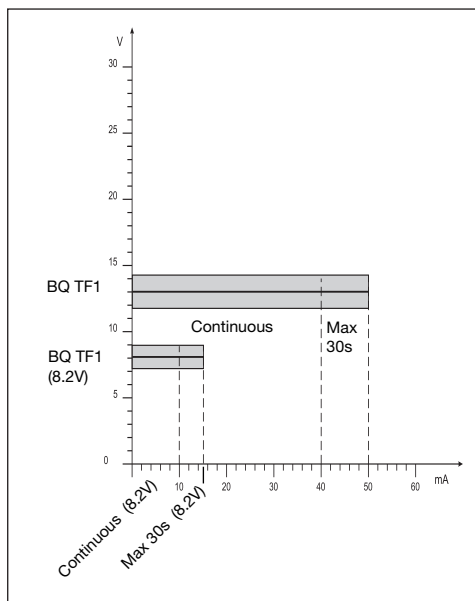

Insulation between inputs and outputs

	Meas. inputs	Relay output	Static output	Analogue output	Serial Port	AUX p.supply	90-260VAC/DC p.supply	18-60VAC/DC p.supply
Meas. inputs	-	4kV	4kV	4kV	4kV	25V	4kV	4kV
Relay Output	4kV	-	2kV	4kV	4kV	4kV	4kV	4kV
Static Output	4kV	2kV	-	4kV	4kV	4kV	4kV	4kV
Analogue Output	4kV	4kV	4kV	-	4kV	4kV	4kV	4kV
Serial Port	4kV	4kV	4kV	4kV	-	4kV	4kV	4kV
AUX p.supply	25V	4kV	4kV	4kV	4kV	-	4kV	4kV
90-260VAC/DC p.supply	4kV	4kV	4kV	4kV	4kV	4kV	-	-
18-60VAC/DC p.supply	4kV	4kV	4kV	4kV	4kV	4kV	-	-

List of selectable functions and variables

	Name	Description	Variables on display
F1	Frequency meter, tachometer	Scaled value of Channel A and Channel B	Channel A and channel B
F2	Period meter	1/A	Channel A and function result
F3	Speed difference	A-B	Channel A and function result
F4	Speed error ratio	(A-B)/B*100	Channel A and function result
F5	Speed ratio	A/B	Channel A and function result
F6	Concentration of a liquid in a mixture	B/(A+B)*100	Channel A and function result
F7	Rotation sensing	Scaled value of Channel A and relevant rotation sensing	Channel A and rotation direction (on the analogue indicator)
F8	Frequency meter + counter	Channel A + counter channel A	Channel A and relevant counter
F9	Frequency meter + counter	Channel A + counter channel B	Counter relevant to channel A and counter relevant to channel B
F10	Dual counter	Counter channel A + counter channel B	Counter relevant to channel A and counter relevant to channel B
F11	Total and partial counter	Counter channel A + counter channel (A+B)	Counter relevant to channel A and counter relevant to the sum of channel A and B

Available modules

Type	N. of channels	Ordering code
UDM60 main unit		BD 60
Pulse signals input: 0.001Hz to 50kHz for DC signals	2	BQ TF1
Pulse signals input: 0.001Hz to 50kHz for AC signals	2	BQ TF2
Analogue output 0 to 20mA, 0 to 10VDC	1	BO AV
Relay output	1	BO R1
Relay output	2	BO R2
Outputs: 2 relays + 2 open collectors	4	BO R4
Relay output	4	BO R5
RS485 Serial Port	1	BR SX
RS232 Serial Port	1	BR SY
Power supply 18 to 60V AC/DC		BP L
Power supply 90 to 260V AC/DC		BP H

Possible module combinations

Basic Unit	Slot A	Slot B	Slot C	Slot D
Measuring inputs: TF1, TF2	●			
RS485 Serial port: SX		●		
RS232 Serial port: SY		●		
Analogue output: AV (*)		●	●	
Relay outputs and/or open collector: R1, R2, R4, R5			●	
Power supply: H, L				●

(*) Up to 1 module max.

Wiring diagrams

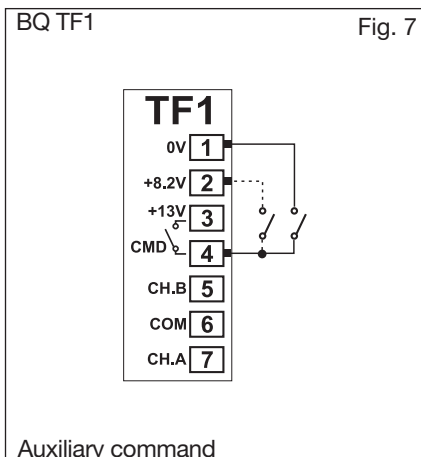
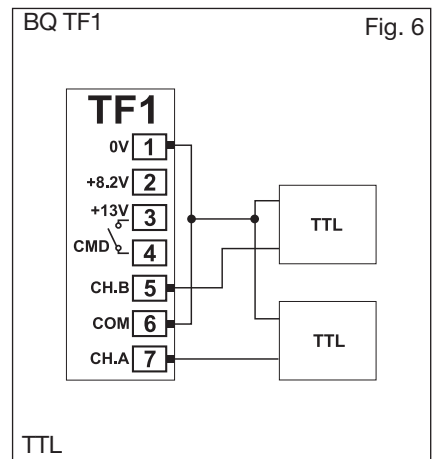
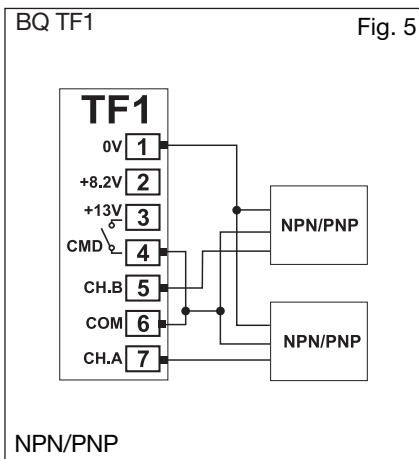
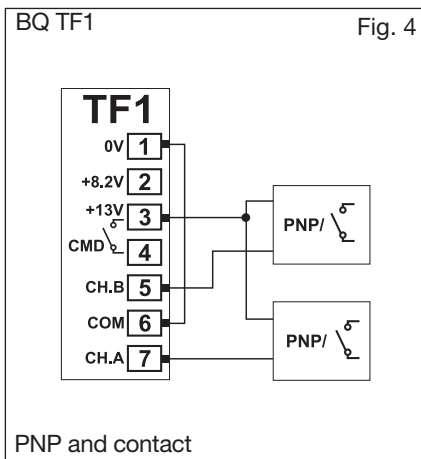
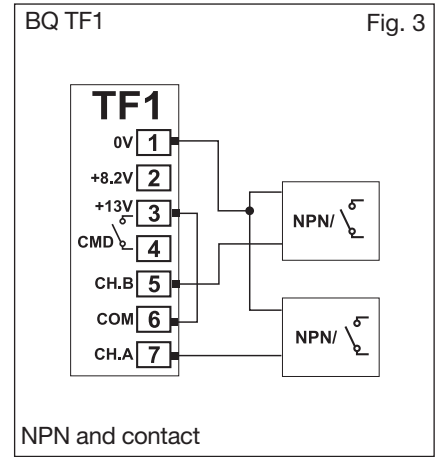
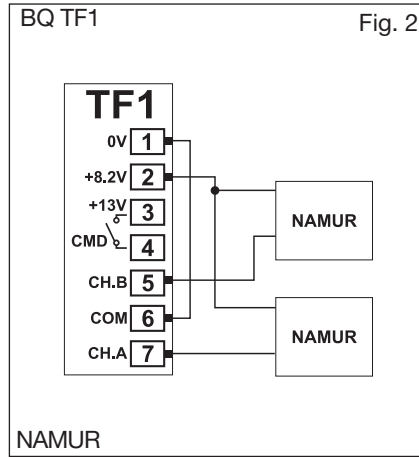
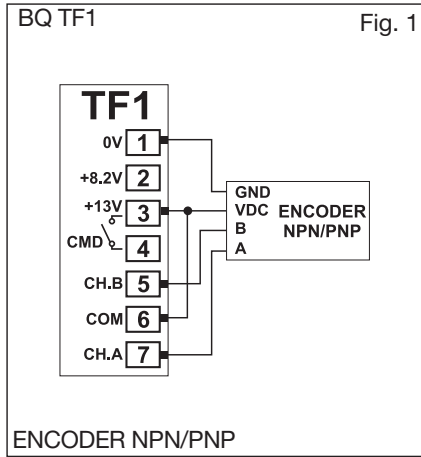

Wiring diagrams (cont.)

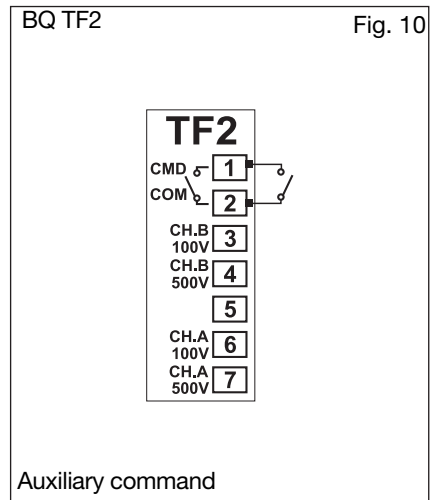
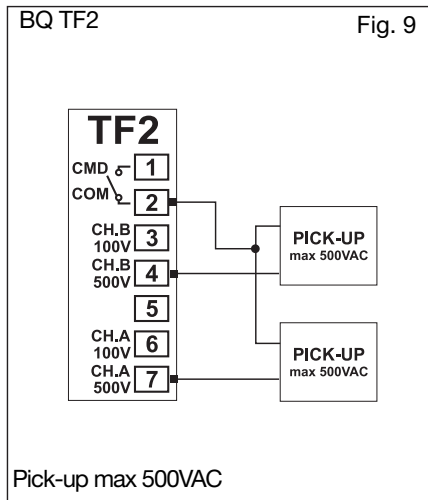
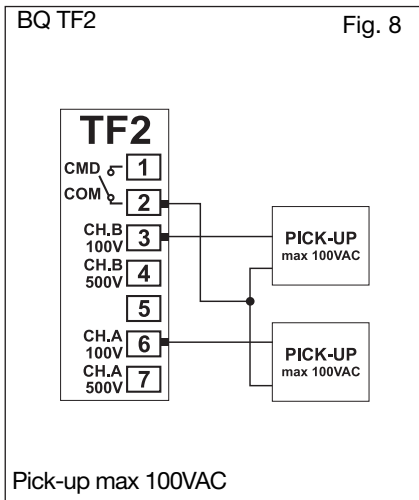

Wiring diagrams for power supply

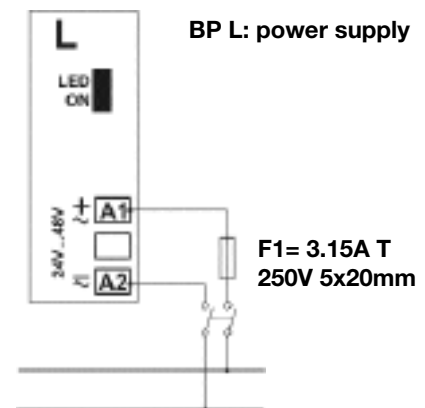
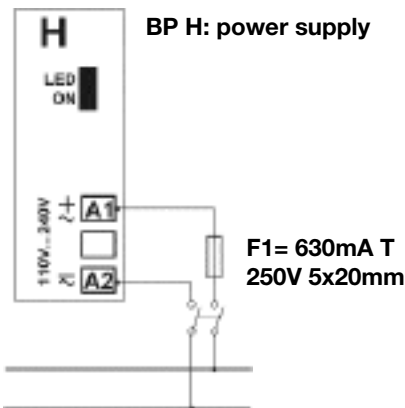

Wiring diagrams of optional modules

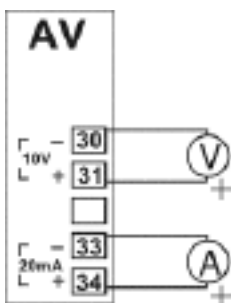

BO AV: analogue output
(10V, 20mA DC)

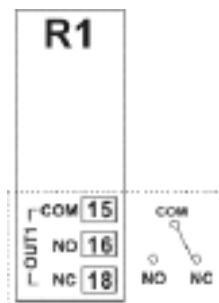

BO R1: 1 relay output

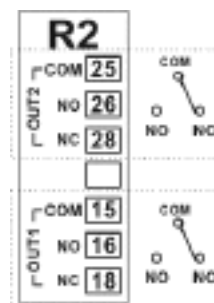

BO R2: 2 relay outputs

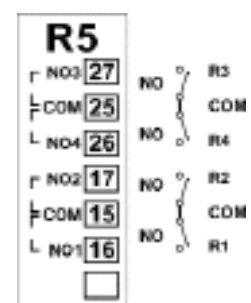

BO R5: 4 relay outputs

Wiring diagrams of optional modules (cont.)

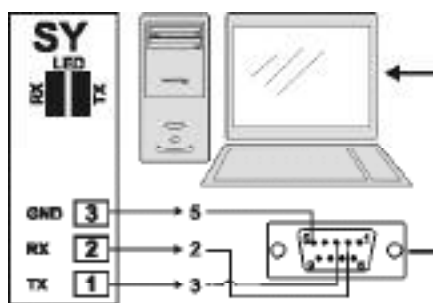
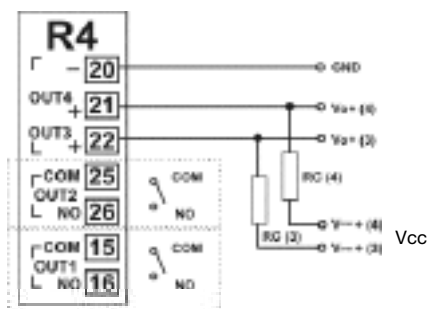

BO SY: RS232 direct connection to PC by means of COM port. RS232 has no termination.

BO R4: dual relay output + dual open collector output: the load resistances (Rc) must be designed so that the close contact current is lower than 100mA; the VDC voltage must be lower than or equal to 30VDC.

VDC: power supply output

Vo+: positive output (open collector transistor).

GND: ground (open collector transistor).

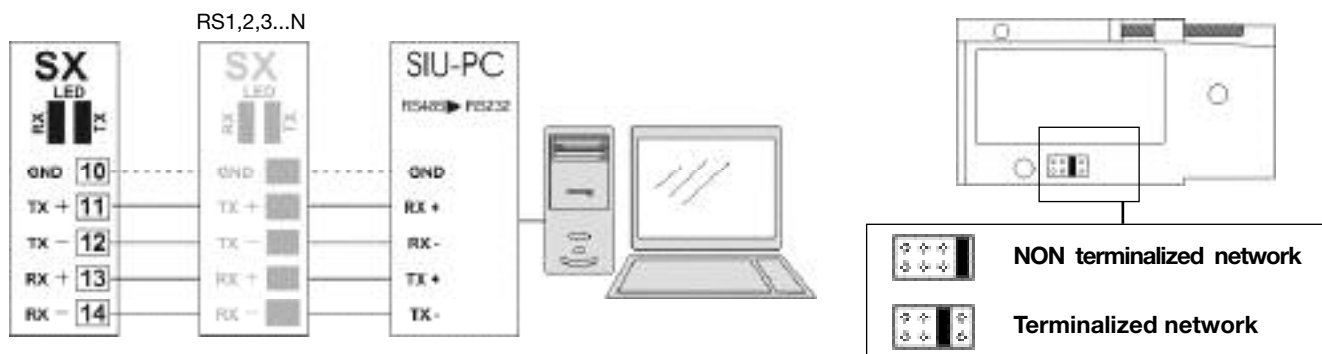

BR SX: RS485 4-wire connection: additional devices provided with RS485 port (indicated as RS1,2,3...N) are connected in parallel. The termination of the serial port is carried out only on the last instrument of the network. The serial module is provided with a jumper for the termination of the RS485 network as shown in the figure above.

Note: particular types of cables or plants may require an external termination. For the network connections use twisted cable type AWG26.

Programming UDM60 by means of PC

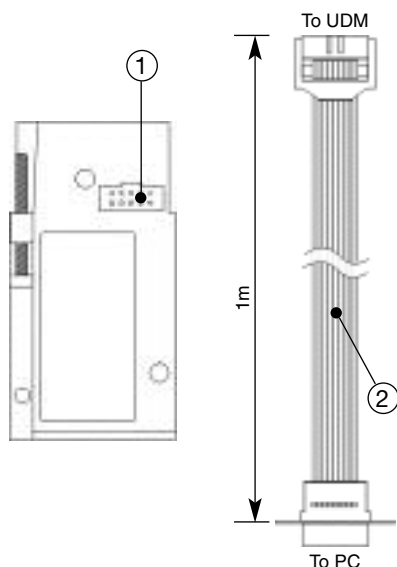

UDM60 is programmable by PC by means of the UdmSoft software (available on request). The user can program all parameters of UDM60 that will be subsequently uploaded and set in the instrument by the RS485 network (BR SX module) or by the RS232 connection (BR SY module). Should UDM60 be equipped without the RS485 or RS232 serial module, all programming parameters will be uploaded and set in the instrument by UdmSoft and the RS232 auxiliary serial connection (1) located on the side of the measuring input module using the special connection cable (2) available on request, as shown in the figures on the left. It is also possible to program the instrument using the dot connector (1) by means of the HyperTerminal Windows functions of a PC.

Note: the RS232 auxiliary port IS NOT insulated from the measuring inputs.

Front panel description

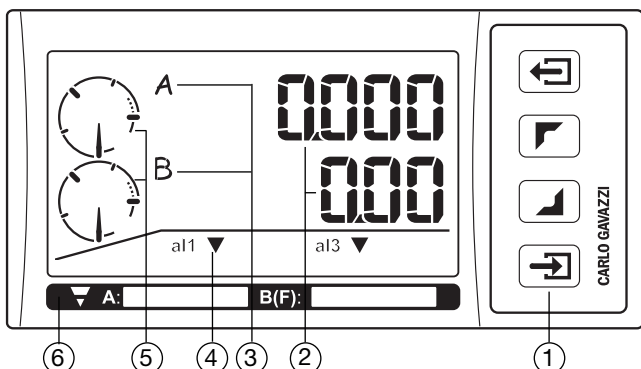

1. Key-pad

The programming of the configuration parameters and the display may be easily controlled by means of the 4 function keys.

: to enter the programming phase and to confirm the password.

 :

- to program values;
- to select functions;
- to scroll display pages.

: for special functions.

2. Display

































































Instantaneous measurements:

- 2 x 6 digit (max display 999999).

Alphanumeric indications by means of LCD display for:

- display of configuration parameters;
- the measured variables.

Engineering Units

 A: RPM	 B(F):	 A: m ²	 B(F):
 A: RPH	 B(F):	 A: km/h	 B(F):
 A: MPH	 B(F):	 A: m/h	 B(F):
 A: ms	 B(F):	 A: cm/h	 B(F):
 A: sec	 B(F):	 A: mm/h	 B(F):
 A: min	 B(F):	 A: kg/m ³	 B(F):
 A: h	 B(F):	 A: g/cm ³	 B(F):
 A: Hz	 B(F):	 A: l/s	 B(F):
 A: kHz	 B(F):	 A: l/min	 B(F):
 A: mm/s	 B(F):	 A: l/h	 B(F):
 A: cm/s	 B(F):	 A: m ³ /s	 B(F):
 A: m/s	 B(F):	 A: m ³ /min	 B(F):
 A: mm/min	 B(F):	 A: m ³ /h	 B(F):
 A: cm/min	 B(F):	 A: kWh	 B(F):
 A: m/min	 B(F):	 A: kvarh	 B(F):
 A: cm ³	 B(F):	 A:	 B(F):

3. Variable type indicators

Display the type of the variables (A for channel A, B for channel B or F for function, min for valley value, max for peak value).

4. Alarm status indicators

Display any alarm condition

5. Analogue indicators

Display graphically the amplitude of the variables with respect to their selected minimum and maximum limits; display overload or underload conditions; display of the rotation direction.

6. Engineering unit

The instrument is supplied with a complete set of self-sticking labels with the main engineering units.

Dimensions and panel cut-out

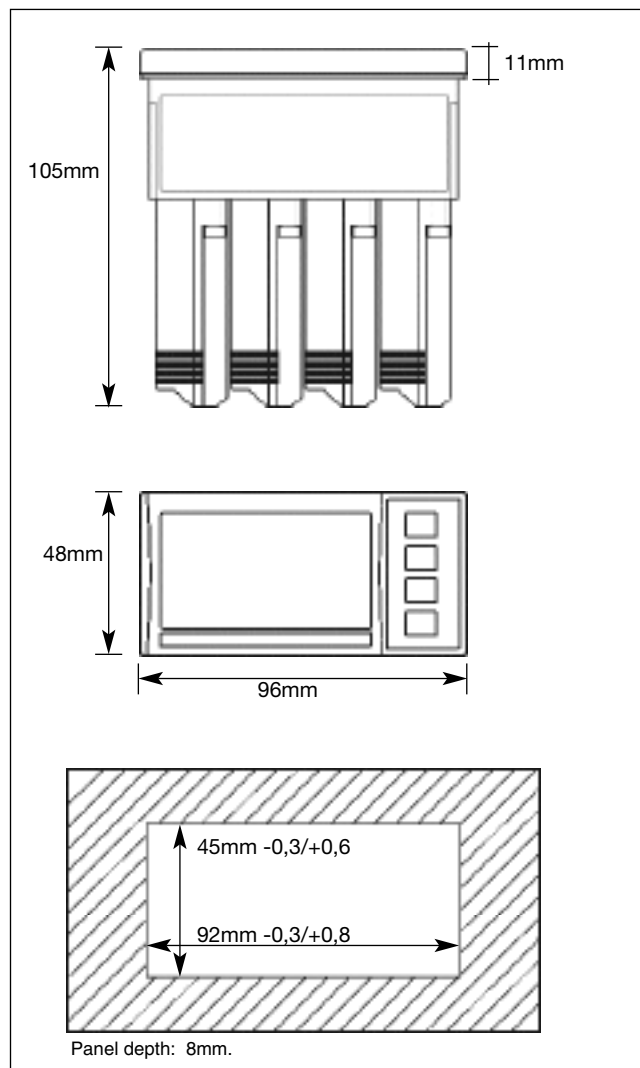

Modules

Input modules



BQ TF1, BQ TF2

Measuring inputs

Output modules



BO AV

Single analogue
output 10V, 20mA DC

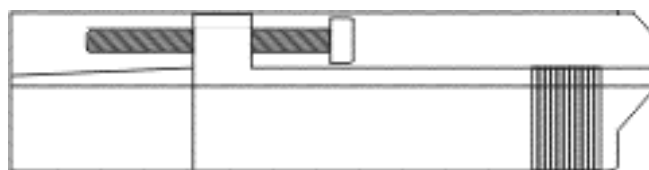

Scale 1:1

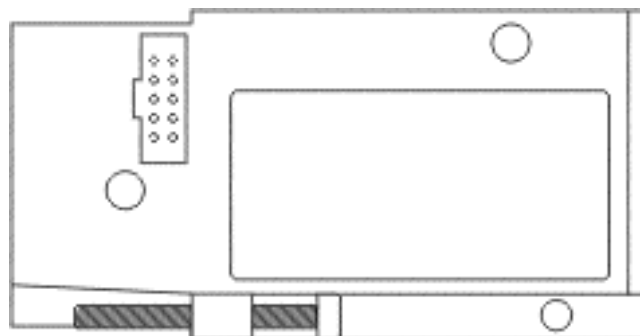

Output modules



BO R1

Single relay output



BO R2

Dual relay output

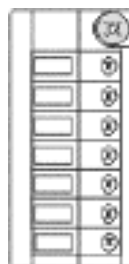

BO R4

Dual relay output +
Dual open collector

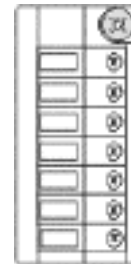

BO R5

4 relay outputs

Serial port modules



BR SX

RS485 Serial port

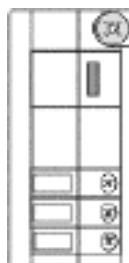

BR SY

RS232 Serial port

Power supply modules

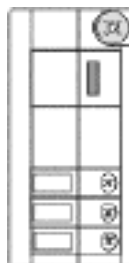

BP H

Power supply:
60 to 260V AC/DC



BP L

Power supply:
18 to 60V AC/DC

Specifications are subject to change without notice UDM60 DS 071207



Vydas International Marketing
Swan House PBC Lynchborough Rd
Passfield Hampshire GU30 7SB UK

Tel: 44(0)1428 751822 Fax: 44(0)1428 751833
Email: info@vydas.co.uk Web: www.vydas.co.uk